

TEMPI DI LAVAGGIO

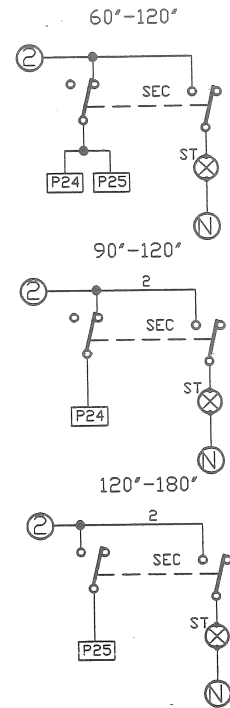

	I	GB	F	D	E
DB	DOSATORE BRILLANTANTE	RINSE-AID METERING UNIT	DOSEUR LIQUIDE DE RINCAGE	KLARSPULER-DOSIERER	DDSIFICADOR ABRILLANTADOR
DD	DOSATORE DETERGENTE	DETERGENT METERING UNIT	DOSEUR PRODUIT DE LAVAGE	SPULMITTEL-DOSIERER	DDSIFICADOR DETERGENTE
E	ELETTROVALVOLA RISCIAQUO	RINSING SOLENOID VALVE	ELECTROVANNE RINCAGE	MAGNETVENTIL SPULEN	ELETTROVALVULA ENJAGUE
ER	ELETTROVALVOLA RIGENERAZIONE	REGENERATION SOLENOID VALVE	ELECTROVANNE REGENERATION	MAGNETVENTIL REGENER.	ELETTROVALVULA REGENERACION
F	FILTRI ANTIDISTURBO	ANTI - JAMMING FILTERS	FILTRE ANTI-DERANGEMENT	ANTISTORUNGSFILTER	FILTROSACUSTICOS
I	INTERRUTTORE GENERALE	MASTER SWITCH	INTERRUPTEUR GENERAL	ALLGEMEINER SCHALT ER	INTERRUPTOR GENERAL
ISP	INTERRUTTORE SICUREZZA PORTA	DOOR SAFETY DEVICE	SECURITE' PORTE	SICHERHEITSDRRICHUNG TUR	SEGURIDAD PUERTA
P	PRESSOSTATO VASCA	TANK PRESSURE SWITCH	PRESSOSTAT CUVE	DRUCKMESSER WANNE	PRESSOSTATO CUBA
PL	POMPA LAVAGGIO	WASH PUMP	POMPE LAVAGE	POMPE WASCHUNG	BOMBA DE LAVADO
PS	POMPA SCARICO	DISCHARGE PUMP	POMPE D'EVACUATION	PUMPE AUSLASS	BOMBA DE DESCARGA
RB	RESISTENZA BOILER	BOILER RESISTANCE	RESISTANCE CHAUFFE-EAU	WIDERSTAND BOILER	RESISTENCIA BOILER
RIG.	PULSANTE RIGENERAZIONE				
RV	RESISTENZA VASCA	TANK RESISTANCE	RESISTANCE CUVE	WIDERSTAND WANNE	RESISTENCIA CUBA
SB	SPIA BOILER	BOILER PILOT LIGHT	LAMPE-TEMOIN CHAUFFE-EAU	KONTROLLEUCHE BOILER	TESTIGUDO BOILER
SC	SPIA CICLO	CYCLE PILOT LIGHT	LAMPE-TEMOIN CYCLE	KONTROLLEUCHE ZIKLUS	TESTIGUDO CICLO
SL	SPIA LINEA	POWER PILOT LIGHT	LAMPE-TEMOIN LIGNE	KONTROLLEUCHE LINIE	TESTIGUDO LINEA
SR	SPIA RIGENERAZIONE	REGENERATION PILOT LIGHT	LAMPE-TEMOIN REGENERATION	KONTROLL REGENERIERERVDORGANG	TESTIGUDO REGENERACION
START	PULSANTE CICLO	CYCLE BUTTON	BOUDON CYCLE	DRUCKNESSER ZYKLUS	BOTON CICLO
T1	TERMOSTATO VASCA	TANK THERMOSTAT	THERMOSTAT CUVE	THERMOSTAT WANNE	TERMOSTATO CUBA
T2	TERMOSTATO BOILER	BOILER THERMOSTAT	THERMOSTAT CHAUFFE-EAU	THERMOSTAT BOILER	TERMOSTATO BOILER
TRB	TELERUTTORE RESISTENZA BOILER	CONTROL SWITCH CONTACT	BOBINE TELERUPTEUR CHAUFFE-EAU	KONTAKT FERNSCHALTER BOILER	CONT. TELERRUPTOR BOILER
TS	TERMOSTATO SICUREZZA	SAFETY DEVICE THERMOSTAT	THERMOSTAT DE SECURITE'	THERMOSTAT SICHERHEILT	TERMOSTATO SEGURIDAD

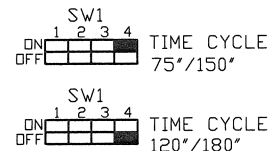
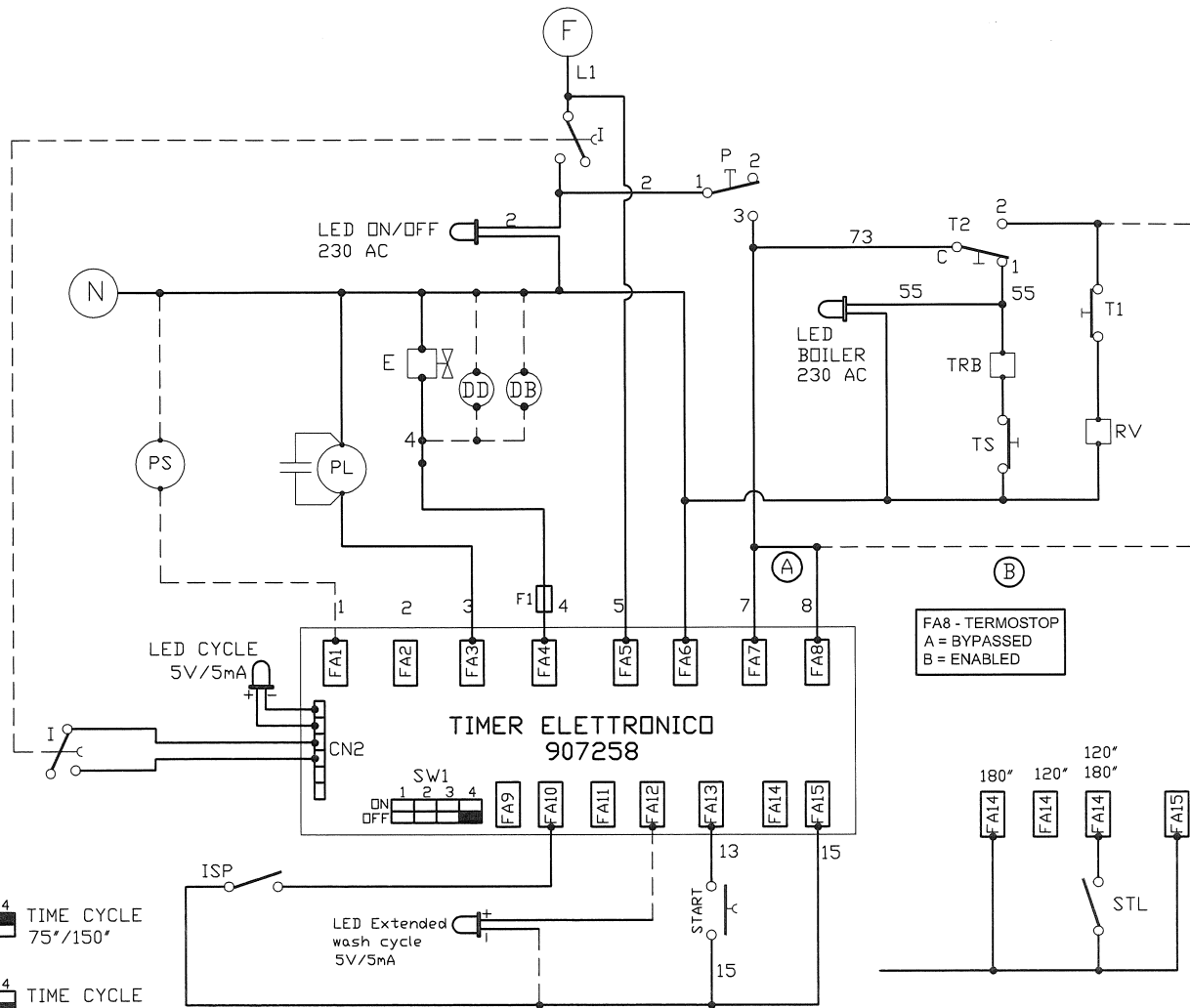
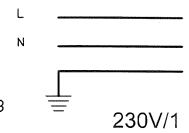
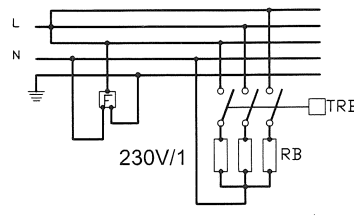
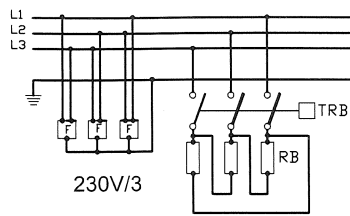
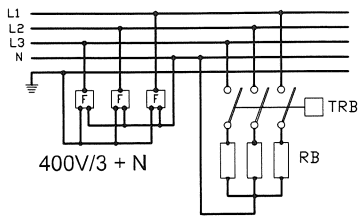

	I	GB	F	D	E
DB	DOSATORE BRILLANTANTE	RINSE-AID METERING UNIT	DOSEUR LIQUIDE DE RINCAGE	KLARSPULER-DOSIERER	DOSIFICADOR ABRILLANTADOR
DD	DOSATORE DETERGENTE	DETERGENT METERING UNIT	DOSEUR PRODUIT DE LAVAGE	SPULMITTEL-DOSIERER	DOSIFICADOR DETERGENTE
E	ELETTROVALVOLA RISCIAACQUO	RINSING SOLENOID VALVE	ELECTROVANNE RINCAGE	MAGNETVENTIL SPULEN	ELECTROVALVULA ENJAGUE
F	FILTRI ANTIDISTURBO	ANTI - JAMMING FILTERS	FILTRE ANTI-DE-RANGEMENT	ANTISTORUNGSMFILTER	FILTROSACUSTICOS
I	INTERRUTTORE GENERALE	MASTER SWITCH	INTERRUPTEUR GENERAL	ALLGEMEINER SCHAL TER	INTERRUPTOR GENERAL
ISP	INTERRUTTORE SICUREZZA PORTA	DOOR SAFETY DEVICE	SECURITE' PORTE	SICHERHEITSVORRICHTUNG TUR	SEGURIDAD PUERTA
P	PRESSOSTATO VASCA	TANK PRESSURE SWITCH	PRESSOSTAT CUVE	DRUCKMESSER WANNE	PRESOSTATO CUBA
PL	POMPA LAVAGGIO	WASH PUMP	POMPE LAVAGE	POMPE WASCUNG	BOMBA DE LAVADO
PS	POMPA SCARICO	DISCHARGE PUMP	POMPE D'E'VACUATION	PUMPE AUSLASS	BOMBA DE DESCARA
RB	RESISTENZA BOILER	BOILER RESISTANCE	RESISTANCE CHAUFFE-EAU	WIDERSTAND BOILER	RESISTENCIA BOILER
RV	RESISTENZA VASCA	TANK RESISTANCE	RESISTANCE CUVE	WIDERSTAND WANNE	RESISTENCIA CUBA
LB	LED BOILER	BOILER LED			
LC	LED CICLO	CYCLE LED			
LL	LED LINEA	POWER LED			
START	PULSANTE CICLO	CYCLE BUTTON	BOUOTON CYCLE	DRUCKNESSER ZYKLUS	BOOTON CICLO
STL	SELETORE TEMPI LAVAGGIO				
T1	TERMOSTATO VASCA	TANK THERMOSTAT	THERMOSTAT CUVE	THERMOSTAT WANNE	TERMOSTATO CUBA
T2	TERMOSTATO BOILER	BOILER THERMOSTAT	THERMOSTAT CHAUFFE-EAU	THERMOSTAT BOILER	TERMOSTATO BOILER
TRB	TELERUTTORE RESISTENZA BOILER	CONTROL SWITCH CONTACT	BOBINE TELERUPTEUR CHAUFFE-EAU	KONTAKT FERNSCHALTER BOILER	CON.T. TELERRUPTOR BOILER
TS	TERMOSTATO SICUREZZA	SAFETY DEVICE THERMOSTAT	THERMOSTAT DE SECURITE'	THERMOSTAT SICHERHEILT	TERMOSTATO SEGURIDAD

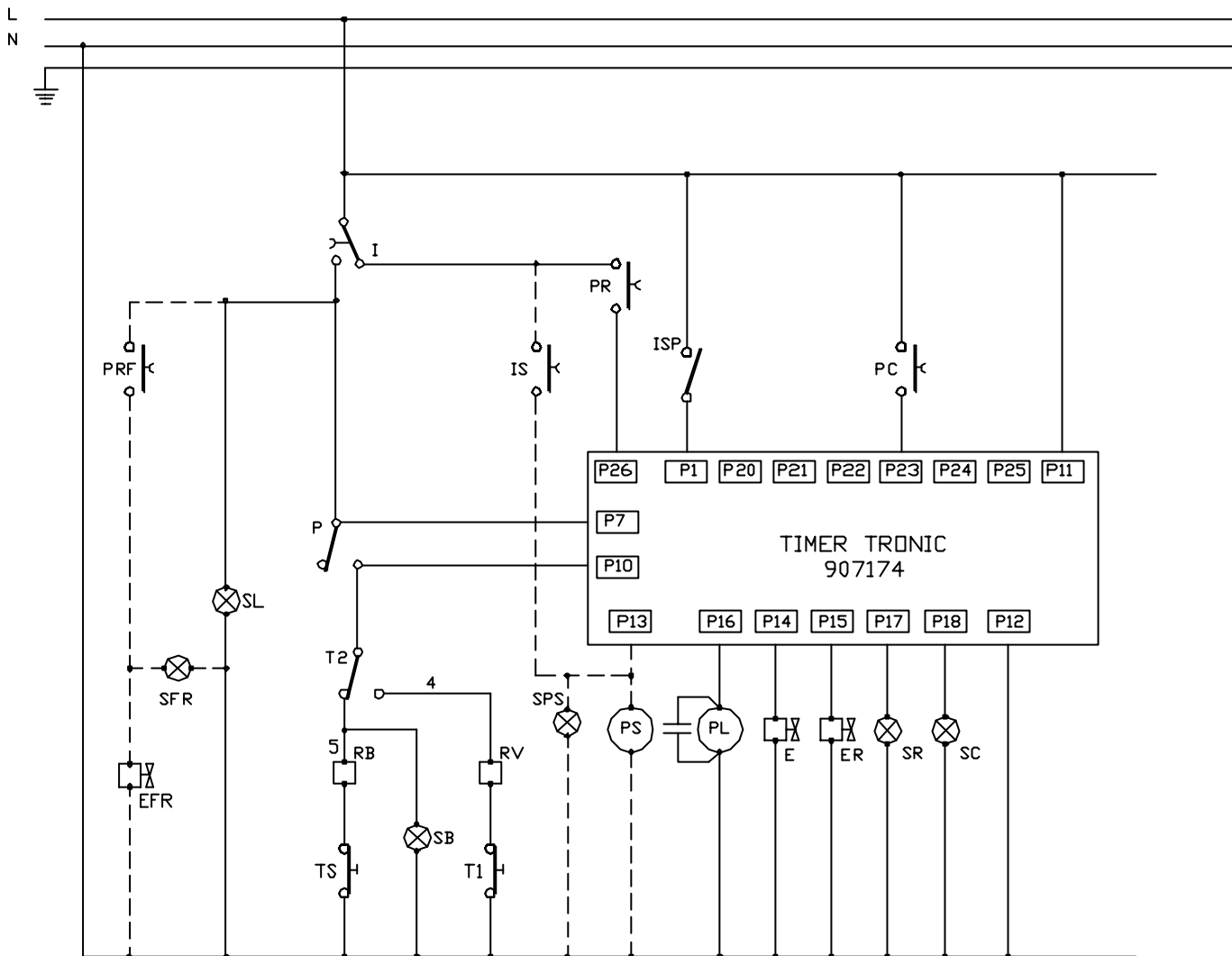

	I	GB	F	D	E
E	ELETTROVALVOLA RISCIAQUO	RINSING SOLENOID VALVE	ELECTROVANNE RINCAGE	MAGNETVENTIL SPULEN	ELECTROVALVULA ENJAGUE
EFR	ELETTROVALVOLA RISC. FREDDO	COLD RINSING SOLENOID VALVE	ELECTROVANNE RINCAGE FROID	MAGNETVENTIL KALTSPULEN	ELECTROVALVULA ENJAGUE EN FRIO
ER	ELETTROVALVOLA RIGENERAZIONE	REGENERATION SOLENOID VALVE	ELECTROVANNE REGENERATION	MAGNETVENTIL REGENER.	ELECTROVALVULA REGENERACION
I	INTERRUTTORE GENERALE	MASTER SWITCH	INTERRUPTEUR GENERAL	ALLGEMEINER SCHALT TER	INTERRUPTOR GENERAL
IS	PULSANTE SCARICO	DISCHARGE BUTTON	BOUTON D'EVACUATION	TASTE AUSLASS	BOTON DE DESCARA
ISP	INTERRUTTORE SICUREZZA PORTA	DOOR SAFETY DEVICE	SECURITE' PORTE	SICHERHEITSVORRICHTUNG TUR	SEGURIDAD PUERTA
P	PRESSOSTATO VASCA	TANK PRESSURE SWITCH	PRESSOSTAT CUVE	DRUCKMESSER WANNE	PRESOSTATO CUBA
PC	PULSANTE CICLO	CYCLE BUTTON	BOUTON CYCLE	DRUCKMESSER ZYKLUS	BOTON CICLO
PFR	PULSANTE RISCIAQUO FREDDO	COLD RINSING BUTTON	BOUTON RINCAGE FROID	TASTE KALTSPULEN	BOTON ENJAGUE EN FRIO
PL	POMPA LAVAGGIO	WASH PUMP	POMPE LAVAGE	POMPE VASCHUNG	BOMBA DE LAVADO
PR	PULSANTE RIGENERAZIONE	REGENERATION BUTTON	BOUTON REGENERATION	TASTE REGENERIERVORGANG	BOTON REGENERACION
PS	POMPA SCARICO	DISCHARGE PUMP	POMPE D'EVACUATION	PUMPE AUSLASS	BOMBA DE DESCARA
RB	RESISTENZA BOILER	BOILER RESISTANCE	RESISTANCE CHAUFFE-EAU	WIDERSTAND BOILER	RESISTENCIA BOILER
RV	RESISTENZA VASCA	TANK RESISTANCE	RESISTANCE CUVE	WIDERSTAND WANNE	RESISTENCIA CUBA
SB	SPIA BOILER	BOILER PILOT LIGHT	LAMPE-TENDON CHAUFFE-EAU	KONTROLLEUCHE BOILER	TESTIGUO BOILER
SC	SPIA CICLO	CYCLE PILOT LIGHT	LAMPE-TENDON CYCLE	KONTROLLEUCHE ZYKLUS	TESTIGUO CICLO
SFR	SPIA RISCIAQUO FREDDO	COLD RINSING PILOT LIGHT	LAMPE-TENDON RINCAGE FROID	KONTROLLEUCHE KALTSPULEN	TESTIGUO ENJAGUE EN FRIO
SL	SPIA LINEA	POWER PILOT LIGHT	LAMPE-TENDON LJGNE	KONTROLLEUCHE LJNIE	TESTIGUO LINEA
SPS	SPIA POMPA SCARICO				
SR	SPIA RIGENERAZIONE	REGENERATION PILOT LIGHT	LAMPE-TENDON REGENERATION	KONTROLL REGENERIERERVORGANG	TESTIGUO REGENERACION
T1	TERMOSTATO VASCA	TANK THERMOSTAT	THERMOSTAT CUVE	THERMOSTAT WANNE	TERMOSTATO CUBA
T2	TERMOSTATO BOILER	BOILER THERMOSTAT	THERMOSTAT CHAUFFE-EAU	THERMOSTAT BOILER	TERMOSTATO BOILER
TS	TERMOSTATO SICUREZZA	SAFETY DEVICE THERMOSTAT	THERMOSTAT DE SECURITE'	THERMOSTAT SICHERHEIT	TERMOSTATO SEGURIDAD

020/024/030 A PS - N19/N22/N27/R20/R23/R29 A PS RF  
CON TIMER ELETTRONICO 120"